



SGM4895

1.3W Fully Differential Audio Power Amplifier

GENERAL DESCRIPTION

The SGM4895 is a fully differential audio power amplifier that is designed for portable communication device applications and demanding applications in mobile phones. It is capable of delivering 1.3W of continuous average power into an 8Ω load with typically 1% distortion (THD+N) from a 5V battery voltage. It operates from 2.5V to 5.5V power supply.

The SGM4895 features a low power consumption shutdown mode. To facilitate this, shutdown may be enabled by logic low. Additionally, the SGM4895 features an internal thermal shutdown protection mechanism.

The SGM4895 contains advanced pop/click circuitry, with a minimal amount of external components. All these features make SGM4895 ideal for wireless handsets and other low voltage applications where minimal power consumption is a primary requirement.

The SGM4895 is available in Green TDFN-3x3-8L and MSOP-8 (Exposed Pad) packages. It operates over an ambient temperature range of -40°C to +85°C.

FEATURES

- **Fully Differential Amplifier**
- **Excellent PSRR: Direct Connection to Battery**
- **1.3W into 8Ω Load from 5V Supply at THD+N = 1% (TYP)**
- **1.6W into 4Ω Load from 5V Supply at THD+N = 1% (TYP, SGM4895YDB8 Only)**
- **2.5V to 5.5V Operation**
- **Low Shutdown Current**
- **Improved Pop/Click Circuitry**
- **Support Single-Ended or Differential Input**
- **Thermal Overload Protection Circuitry**
- **No Output Coupling Capacitors, Bootstrap Capacitors Required**
- **External Gain Configuration Capability**
- **-40°C to +85°C Operating Temperature Range**
- **Available in Green TDFN-3x3-8L and MSOP-8 (Exposed Pad) Packages**

APPLICATIONS

Portable Systems
Wireless Handsets
Mobile Phone
Handheld Computers
PDAs
GPS

PACKAGE/ORDERING INFORMATION

MODEL	PACKAGE DESCRIPTION	SPECIFIED TEMPERATURE RANGE	ORDERING NUMBER	PACKAGE MARKING	PACKING OPTION
SGM4895	TDFN-3x3-8L	-40°C to +85°C	SGM4895YDB8/TR	SGM 4895DB XXXXX	Tape and Reel, 3000
	MSOP-8 (Exposed Pad)	-40°C to +85°C	SGM4895YPMS8/TR	SGM4895 YPMS8 XXXXX	Tape and Reel, 4000

NOTE: XXXXX = Date Code and Vendor Code.

Green (RoHS & HSF): SG Micro Corp defines "Green" to mean Pb-Free (RoHS compatible) and free of halogen substances. If you have additional comments or questions, please contact your SGMICRO representative directly.

ABSOLUTE MAXIMUM RATINGS

Supply Voltage.....6V
 Input Voltage Range -0.3V to (V₊) + 0.3V
 Junction Temperature+150°C
 Storage Temperature Range.....-65°C to +150°C
 Lead Temperature (Soldering, 10s)+260°C
 ESD Susceptibility
 HBM..... 2000V
 MM..... 400V

RECOMMENDED OPERATING CONDITIONS

Supply Voltage Range2.5V to 5.5V
 Operating Temperature Range-40°C to +85°C

OVERSTRESS CAUTION

Stresses beyond those listed may cause permanent damage to the device. Functional operation of the device at these or any other conditions beyond those indicated in the operational section of the specification is not implied. Exposure to absolute maximum rating conditions for extended periods may affect reliability.

ESD SENSITIVITY CAUTION

This integrated circuit can be damaged by ESD if you don't pay attention to ESD protection. SGMICRO recommends that all integrated circuits be handled with appropriate precautions. Failure to observe proper handling and installation procedures can cause damage. ESD damage can range from subtle performance degradation to complete device failure. Precision integrated circuits may be more susceptible to damage because very small parametric changes could cause the device not to meet its published specifications.

DISCLAIMER

SG Micro Corp reserves the right to make any change in circuit design, specification or other related things if necessary without notice at any time.

PIN CONFIGURATIONS

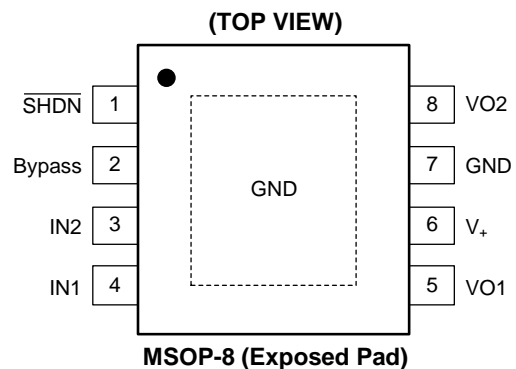
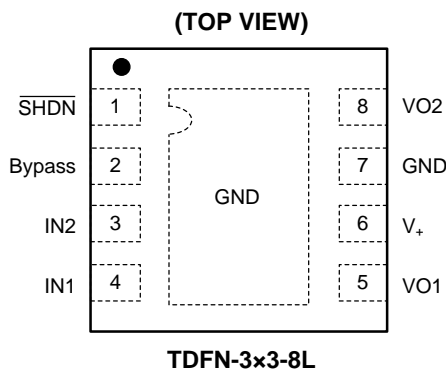

ELECTRICAL CHARACTERISTICS

(The following AC specifications apply for 8Ω load, $A_V = 1V/V$, $T_A = +25^\circ\text{C}$, unless otherwise specified.)

PARAMETER	SYMBOL	CONDITIONS	MIN	TYP	MAX	UNITS	
Supply Voltage	V_+		2.5		5.5	V	
Shutdown Current	I_{SD}	$V_{IN} = 0V, V_{SHDN} = GND$		0.01	1	μA	
Output Offset Voltage	V_{OS}	$V_{IN} = 0V, V_{SHDN} = V_+ = 5.0V$	-10	2.5	10	mV	
		$V_{IN} = 0V, V_{SHDN} = V_+ = 3.3V$	-10	2.0	10		
		$V_{IN} = 0V, V_{SHDN} = V_+ = 2.6V$		2.0			
Quiescent Power Supply Current	I_Q	$V_{IN} = 0V, I_O = 0A,$ $V_{SHDN} = V_+$	$V_+ = 5.0V, \text{No Load}$		4.70	7.50	mA
			$V_+ = 5.0V, 8\Omega \text{ Load}$		4.75	8.00	
			$V_+ = 3.3V, \text{No Load}$		3.87	5.80	
			$V_+ = 3.3V, 8\Omega \text{ Load}$		3.90	6.00	
			$V_+ = 2.6V, \text{No Load}$		3.20		
			$V_+ = 2.6V, 8\Omega \text{ Load}$		3.22		
Shutdown Voltage Input High	V_{SDIH}		1.2			V	
Shutdown Voltage Input Low	V_{SDIL}				0.4	V	
Output Power (8Ω)	P_O	$f = 1\text{kHz}$ THD+N = 1%	$V_+ = 5.0V$		1.30		W
			$V_+ = 3.6V$		0.65		
			$V_+ = 3.0V$		0.45		
			$V_+ = 2.6V$		0.34		
		$f = 1\text{kHz}$ THD+N = 10%	$V_+ = 5.0V$		1.60		
			$V_+ = 3.6V$		0.82		
			$V_+ = 3.0V$		0.55		
			$V_+ = 2.6V$		0.42		
Output Power (4Ω)	P_O	$f = 1\text{kHz}$ THD+N = 1% SGM4895YDB8 only	$V_+ = 5.0V$		1.60		W
			$V_+ = 3.6V$		1.00		
			$V_+ = 3.0V$		0.65		
			$V_+ = 2.6V$		0.50		
		$f = 1\text{kHz}$ THD+N = 10% SGM4895YDB8 only	$V_+ = 5.0V$		2.20		
			$V_+ = 3.6V$		1.25		
			$V_+ = 3.0V$		0.85		
			$V_+ = 2.6V$		0.60		
Total Harmonic Distortion + Noise	THD+N	$P_O = 0.6W_{rms}, f = 1\text{kHz}, V_+ = 5.0V$		0.015		%	
Power Supply Rejection Ratio ^{(1) (2)}	PSRR	$f = 217\text{Hz}$	$V_+ = 5.0V$		-83	dB	
			$V_+ = 3.6V$		-80		
			$V_+ = 3.0V$		-73		
			$V_+ = 2.6V$		-65		
		$f = 1\text{kHz}$	$V_+ = 5.0V$		-83		
			$V_+ = 3.6V$		-80		
			$V_+ = 3.0V$		-73		
			$V_+ = 2.6V$		-65		
Common Mode Rejection Ratio ⁽²⁾	CMRR	$f = 217\text{Hz}, V_{CM} = 200\text{mV}_{P-P}, V_+ = 5.0V$		-76		dB	
Wake-Up Time	T_{WU}	$C_B = 1\mu\text{F}$	$V_+ = 5.0V$		50	ms	
			$V_+ = 3.6V$		42		
			$V_+ = 3.0V$		37		
			$V_+ = 2.6V$		32		

NOTES:

- 10Ω terminated input.
- PSRR and CMRR are affected by the matching between gain-setting resistor ratios.

TYPICAL PERFORMANCE CHARACTERISTICS

At $T_A = +25^\circ\text{C}$, $A_V = 1$, $f = 1\text{kHz}$, $C_B = 1\mu\text{F}$, unless otherwise noted.

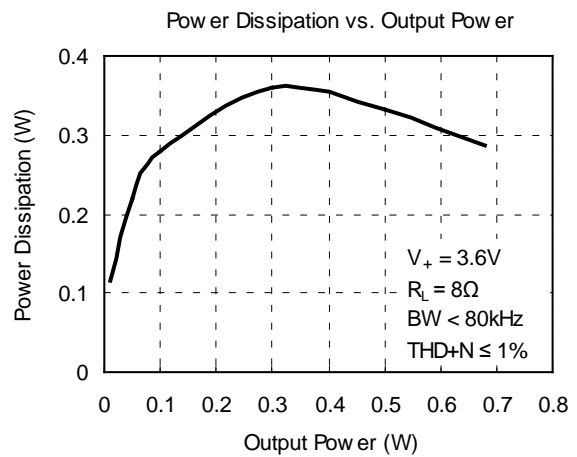
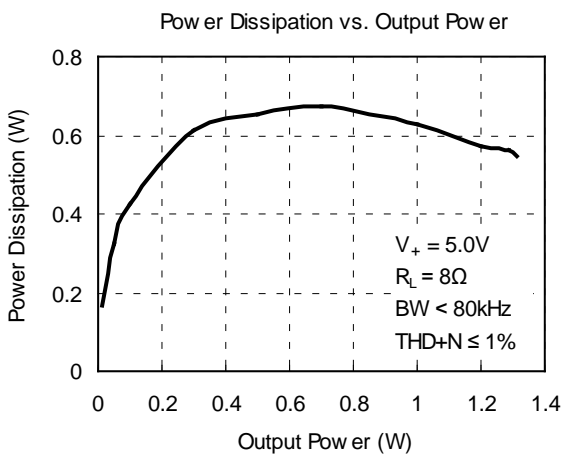
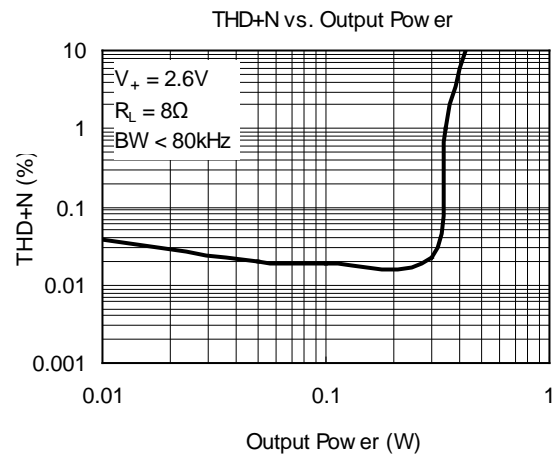
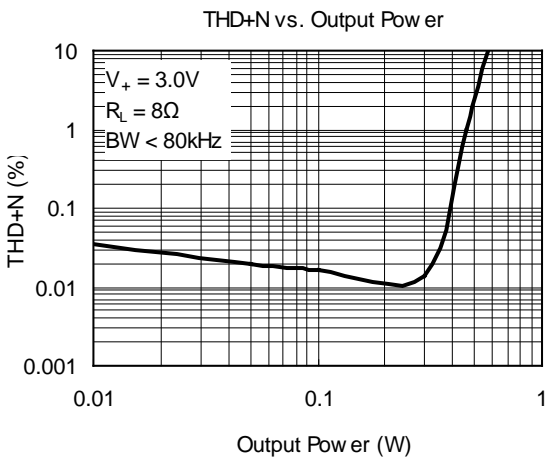
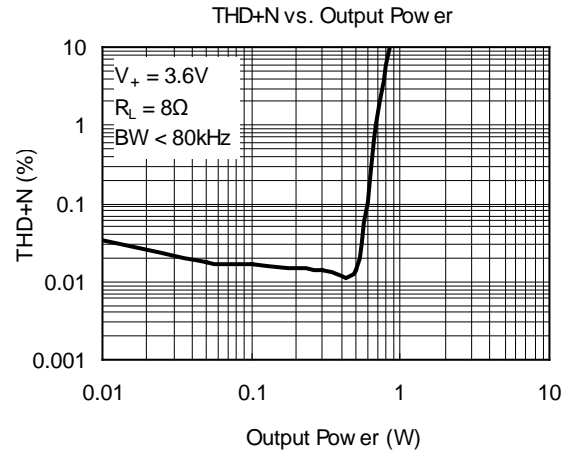
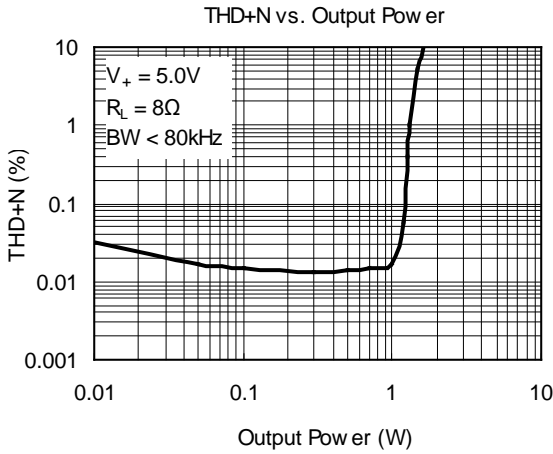

TYPICAL PERFORMANCE CHARACTERISTICS (continued)

At $T_A = +25^\circ\text{C}$, $A_V = 1$, $f = 1\text{kHz}$, $C_B = 1\mu\text{F}$, unless otherwise noted.

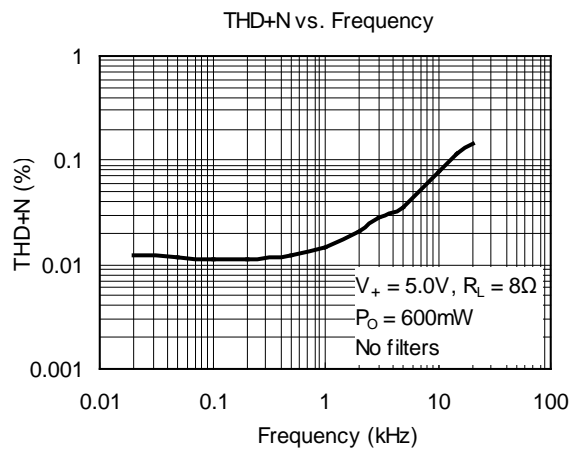
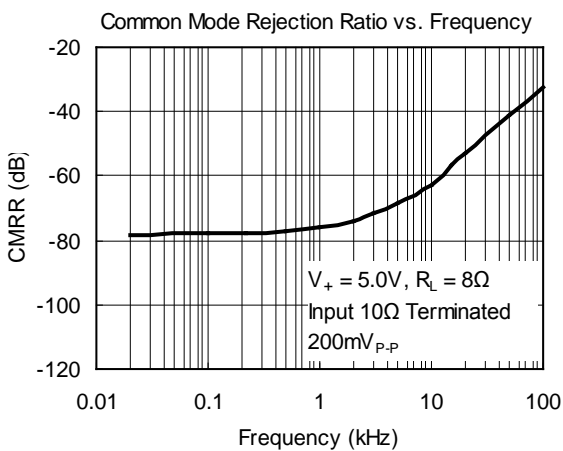
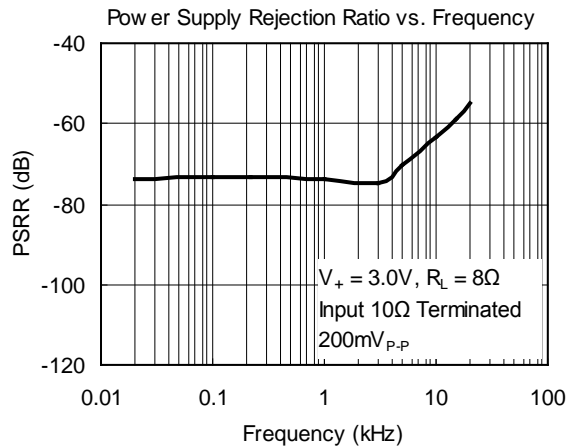
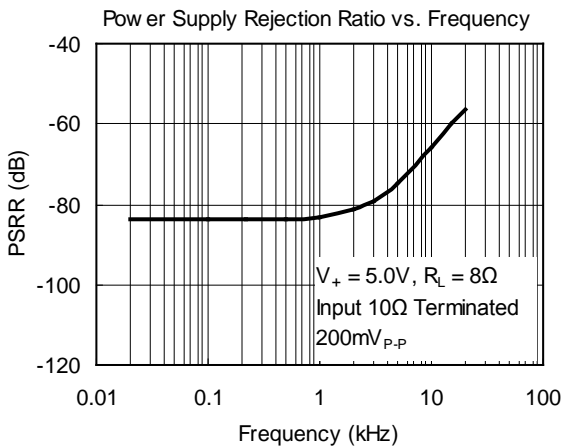
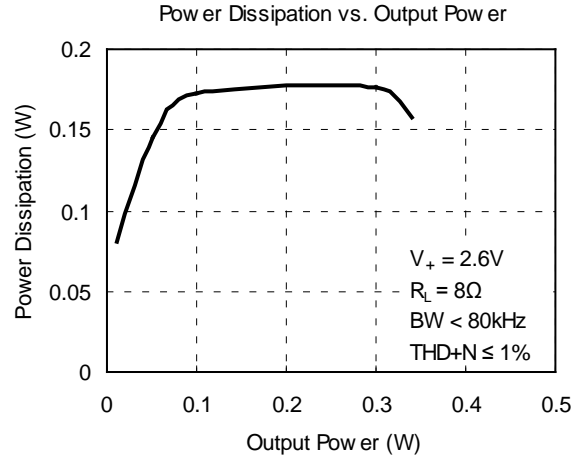
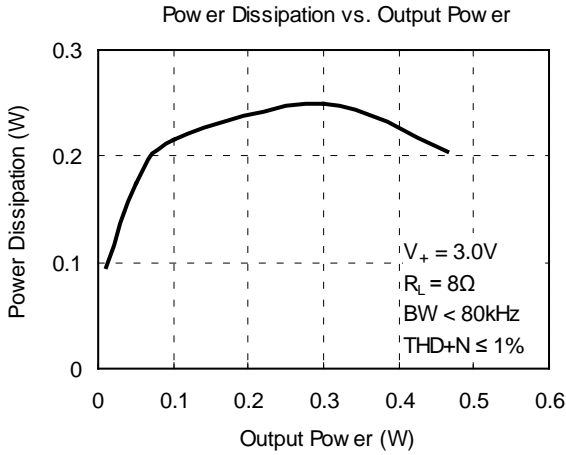

TYPICAL PERFORMANCE CHARACTERISTICS (continued)

At $T_A = +25^\circ\text{C}$, $A_V = 1$, $f = 1\text{kHz}$, $C_B = 1\mu\text{F}$, unless otherwise noted.

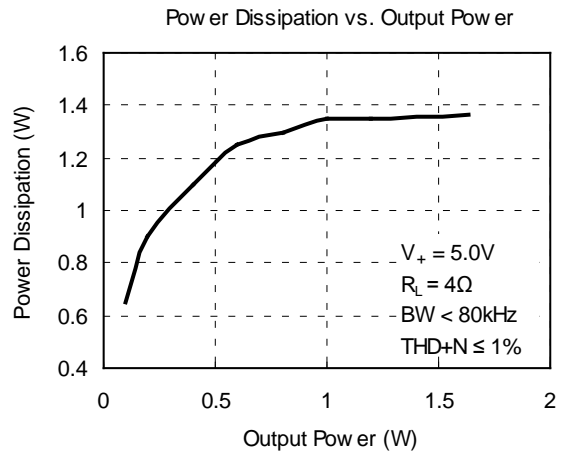
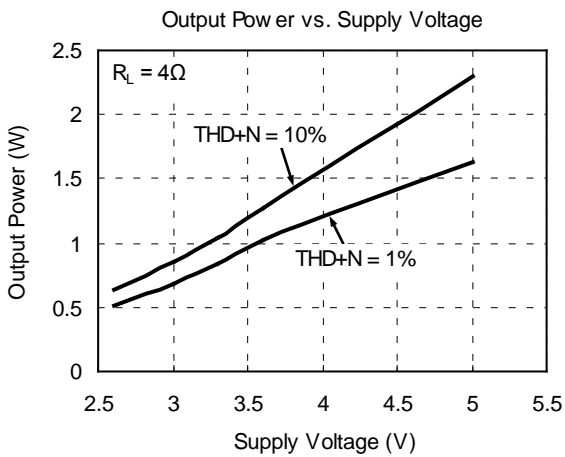
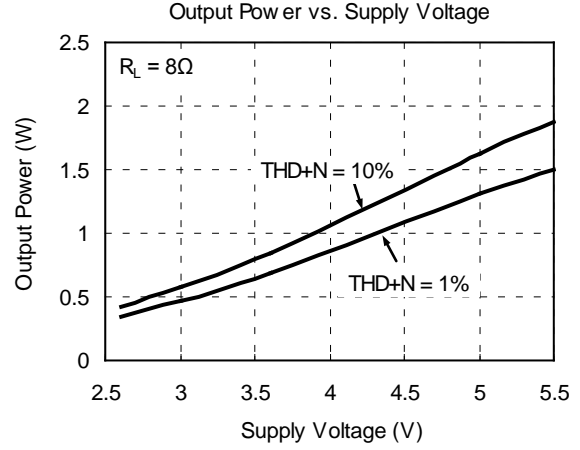
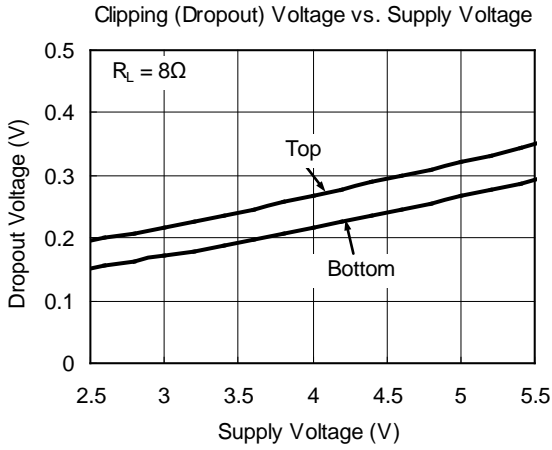

TYPICAL APPLICATIONS

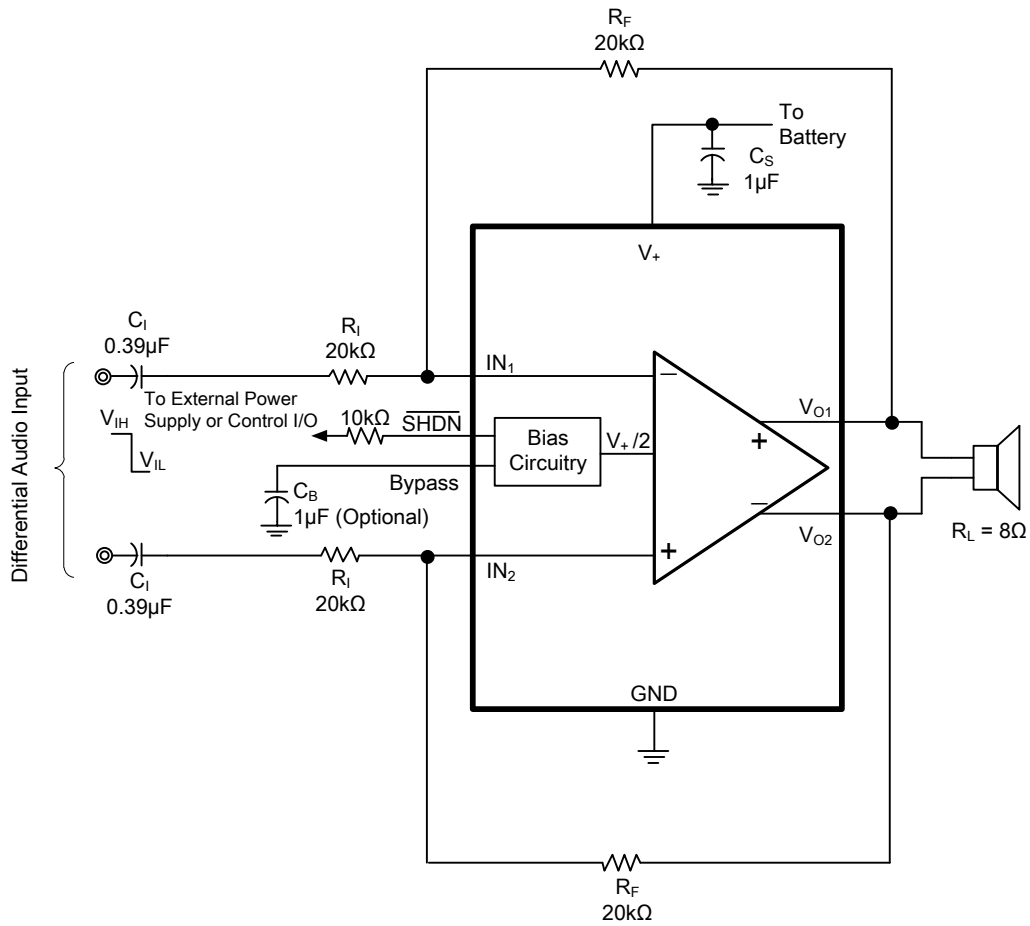

NOTE: A 10kΩ resistor must be serially connected to $\overline{\text{SHDN}}$ pin.

Figure 1. Typical Differential Input Application Schematic

TYPICAL APPLICATIONS (continued)

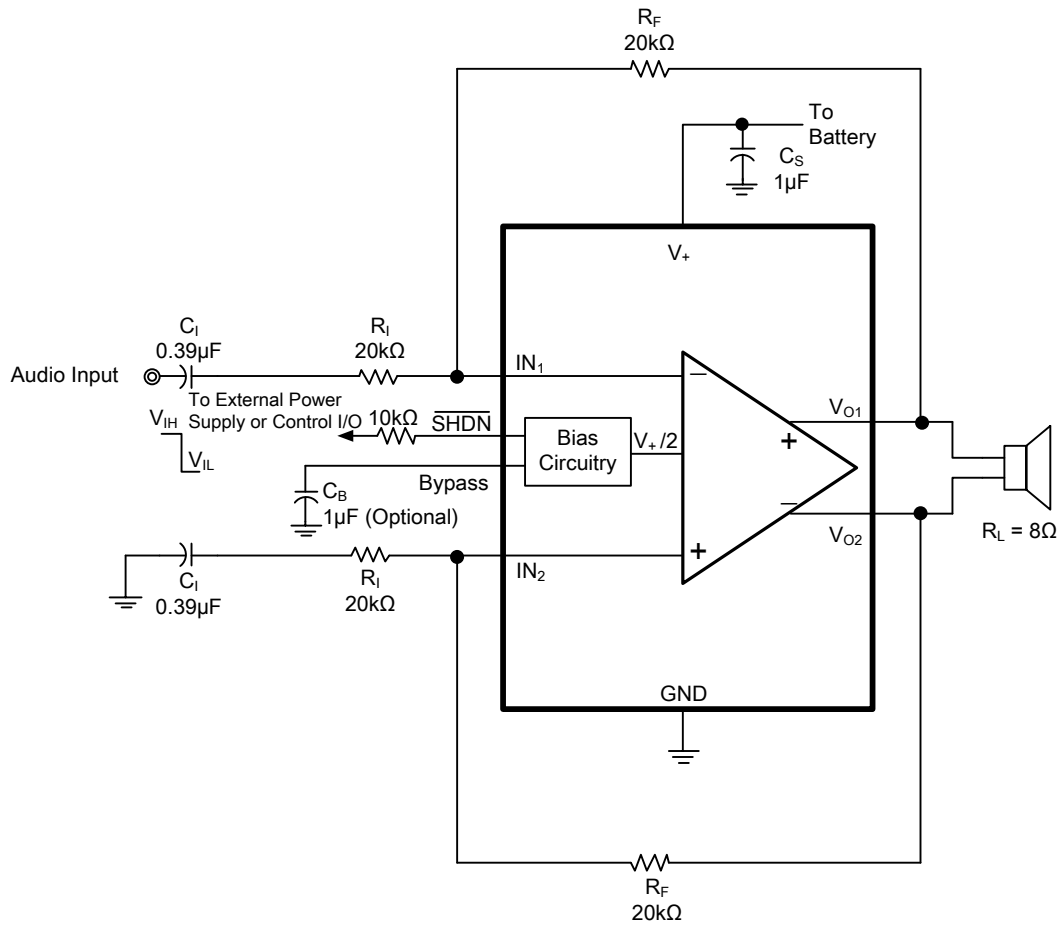

NOTE: A 10kΩ resistor must be serially connected to $\overline{\text{SHDN}}$ pin.

Figure 2. Single-Ended Input Application Schematic

APPLICATION NOTES

PCB Design Recommendations (Thermal Design Considerations)

With proper thermal design considerations, SGM4895YDB8 is capable of delivering 1.6W of continuous average power into a 4Ω load at 5V power supply.

Thermal Land

The TDFN-3x3-8L thermal land is a metal (normally copper) region centrally located under the package and on top of the PCB. It has a rectangular or square shape and should match the dimensions of the exposed pad on the bottom of the package (1:1 ratio).

For certain high power applications, the PCB land may be modified to a "dog bone" shape that enhances thermal performance. The packages used with the "dog bone" lands will be a dual inline configuration (see Figure 3).

Top View

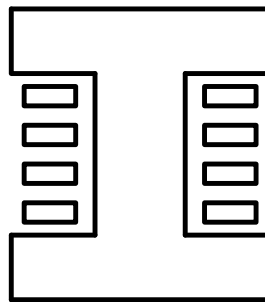

Figure 3. Dog Bone

Thermal Vias

Thermal vias are necessary. They conduct heat from the exposed pad of the package to the ground plane. The number of vias is application specific and is dependent upon electrical requirements and power dissipation.

The via diameter should be 0.2mm to 0.33mm with 1oz. copper via barrel plating. It is important to plug the via to avoid any solder wicking inside the via during the soldering process. The thermal vias can be tented with solder mask on the top surface of the PCB. The solder mask diameter should be at least 75microns (or 3mils) larger than the via diameter. The solder mask thickness should be the same across the entire PCB.

A package thermal performance may be improved by increasing the number of vias.

PACKAGE OUTLINE DIMENSIONS

TDFN-3x3-8L

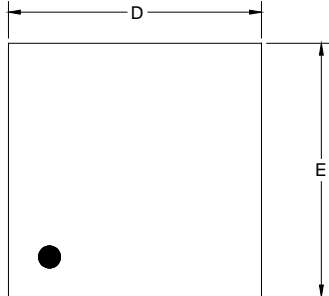

TOP VIEW

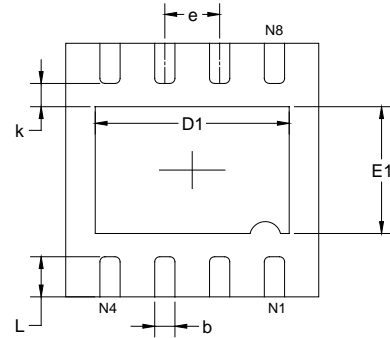

BOTTOM VIEW

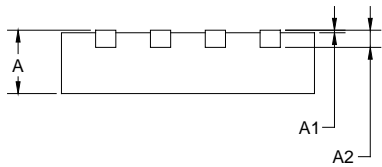

SIDE VIEW

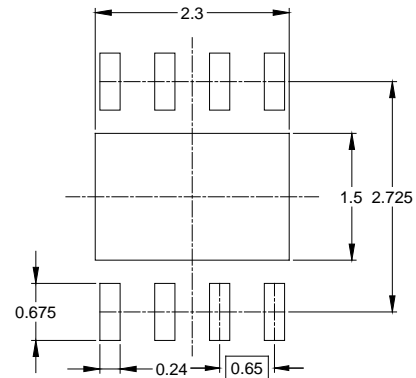

RECOMMENDED LAND PATTERN (Unit: mm)

Symbol	Dimensions In Millimeters		Dimensions In Inches	
	MIN	MAX	MIN	MAX
A	0.700	0.800	0.028	0.031
A1	0.000	0.050	0.000	0.002
A2	0.203 REF		0.008 REF	
D	2.900	3.100	0.114	0.122
D1	2.200	2.400	0.087	0.094
E	2.900	3.100	0.114	0.122
E1	1.400	1.600	0.055	0.063
k	0.200 MIN		0.008 MIN	
b	0.180	0.300	0.007	0.012
e	0.650 TYP		0.026 TYP	
L	0.375	0.575	0.015	0.023

PACKAGE OUTLINE DIMENSIONS

MSOP-8 (Exposed Pad)

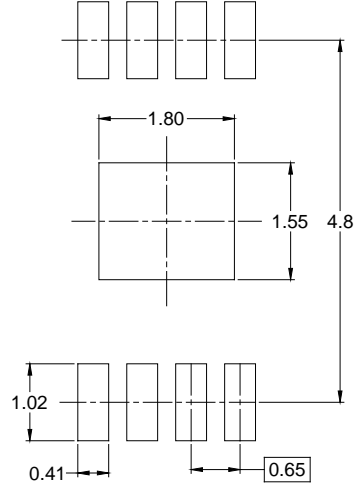
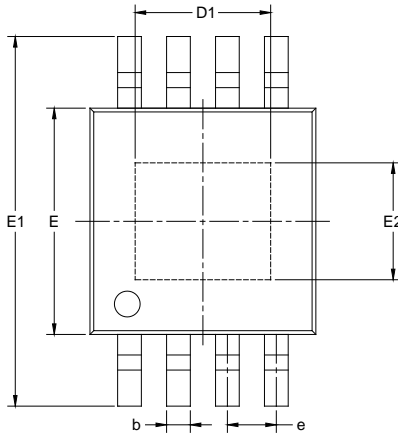

RECOMMENDED LAND PATTERN (Unit: mm)

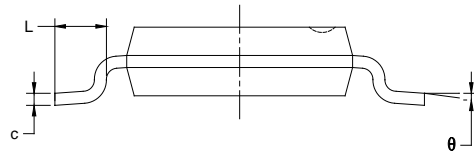
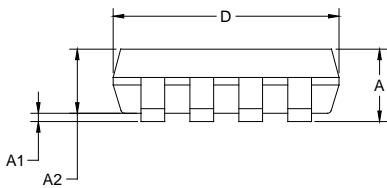

Symbol	Dimensions In Millimeters		Dimensions In Inches	
	MIN	MAX	MIN	MAX
A	0.820	1.100	0.032	0.043
A1	0.020	0.150	0.001	0.006
A2	0.750	0.950	0.030	0.037
b	0.250	0.380	0.010	0.015
c	0.090	0.230	0.004	0.009
D	2.900	3.100	0.114	0.122
D1	1.700	1.900	0.067	0.075
e	0.65 BSC		0.026 BSC	
E	2.900	3.100	0.114	0.122
E1	4.750	5.050	0.187	0.199
E2	1.450	1.650	0.057	0.065
L	0.400	0.800	0.016	0.031
θ	0°	6°	0°	6°

TAPE AND REEL INFORMATION

REEL DIMENSIONS

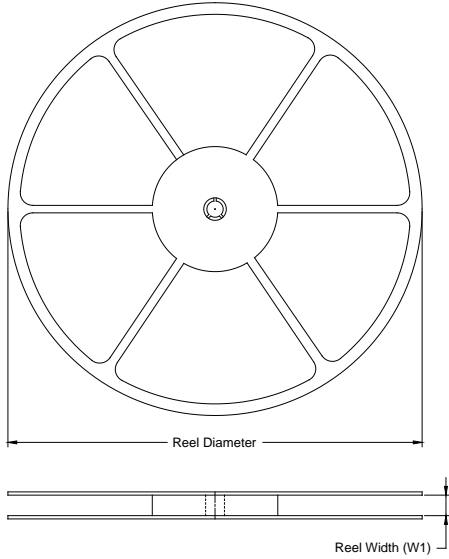

TAPE DIMENSIONS

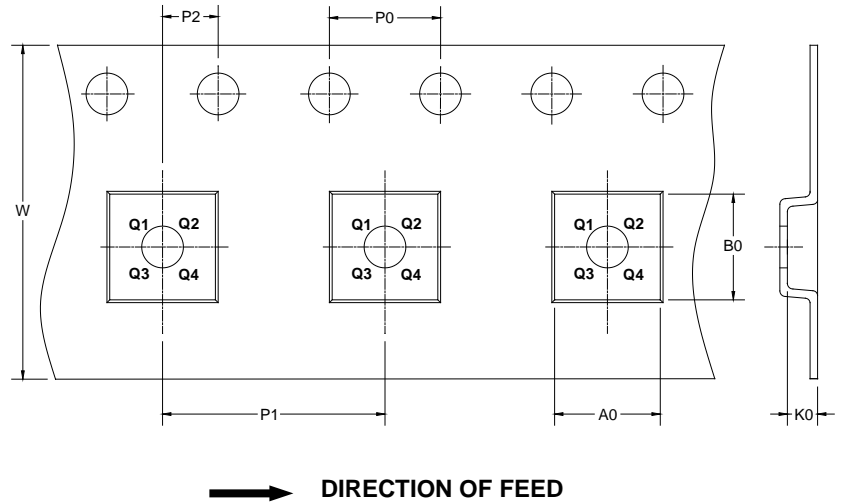

NOTE: The picture is only for reference. Please make the object as the standard.

KEY PARAMETER LIST OF TAPE AND REEL

Package Type	Reel Diameter	Reel Width W1 (mm)	A0 (mm)	B0 (mm)	K0 (mm)	P0 (mm)	P1 (mm)	P2 (mm)	W (mm)	Pin1 Quadrant
TDFN-3x3-8L	13"	12.4	3.35	3.35	1.13	4.0	8.0	2.0	12.0	Q1
MSOP-8 (Exposed Pad)	13"	12.4	5.20	3.30	1.50	4.0	8.0	2.0	12.0	Q1

D00001

PACKAGE INFORMATION

CARTON BOX DIMENSIONS



NOTE: The picture is only for reference. Please make the object as the standard.

KEY PARAMETER LIST OF CARTON BOX

Reel Type	Length (mm)	Width (mm)	Height (mm)	Pizza/Carton
13"	386	280	370	5

DD0002